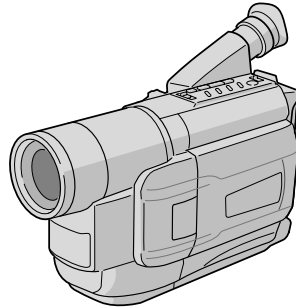

COMPACT VHS CAMCORDER

JVC

GR-SXM745

**S VHS C***Super VHS
Super VHS ET***For Customer Use:**

Enter below the Model No. and Serial No. which is located on the bottom of the camcorder. Retain this information for future reference.

Model No.

Serial No.

U  Printed in Malaysia
1101MKV*UN*PJ

COPYRIGHT© 2001 VICTOR COMPANY OF JAPAN, LTD

Dear Customer,

- Thank you for purchasing the JVC Compact VHS camcorder. Before use, please read "PRECAUTIONS" (pg. 3, 4) to ensure safe use of this product.

AUTOMATIC DEMONSTRATION

Automatic Demonstration takes place when "DEMO MODE" is set to "ON" (factory-preset).

- Available when the Power Switch **12** is set to "A" or "M".
- Performing any operation during the demonstration stops the demonstration temporarily. If no operation is performed for more than 1 minute after that, the demonstration will resume.
- "DEMO MODE" remains "ON" even if the camcorder power is turned off.
- To cancel Automatic Demonstration, set the Power Switch **12** to "M" and press the MENU Wheel **1** in while the demo is in progress. This takes you directly to the demo mode's Setting Menu (so you will not have to go through the main Menu Screen). Rotate the MENU Wheel **1** to select "OFF" and press it.

NOTES:

- When a tape whose Erase Protection tab is in the position that allows recording is loaded in the camcorder, demonstration is not available.
- If you do not detach the Lens Cap, you cannot see the actual changes of the Automatic Demonstration activated on the LCD monitor or viewfinder.

PROVIDED ACCESSORIES

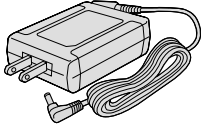

• AC Adapter

AP-V12U, AP-V11U or AP-V10U

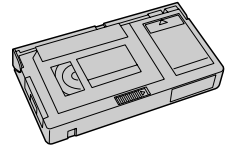
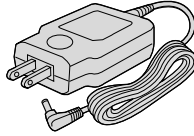

• Cassette Adapter
C-P7U

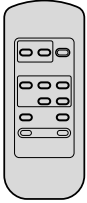

• Remote Control Unit
RM-V715U

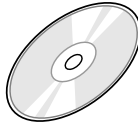

• CD-ROM

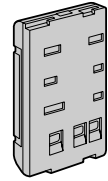

• Battery Pack
BN-V11U



• Lens Cap

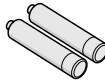

• AAA (R03) Battery x 2
(for Remote Control Unit)



• AA (R6) Battery
(for Cassette Adapter)

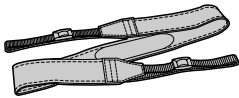

• Shoulder Strap





• PC Connection Cable

NOTE:

In order to maintain optimum performance of the camcorder, provided cables may be equipped with one or more core filter. If a cable has only one core filter, the end that is closest to the filter should be connected to the camcorder.

SAFETY PRECAUTIONS

	CAUTION RISK OF ELECTRIC SHOCK DO NOT OPEN	
CAUTION: TO REDUCE THE RISK OF ELECTRIC SHOCK, DO NOT REMOVE COVER (OR BACK). NO USER-SERVICEABLE PARTS INSIDE. REFER SERVICING TO QUALIFIED SERVICE PERSONNEL.		



The lightning flash with arrowhead symbol, within an equilateral triangle, is intended to alert the user to the presence of uninsulated "dangerous voltage" within the product's enclosure that may be of sufficient magnitude to constitute a risk of electric shock to persons.



The exclamation point within an equilateral triangle is intended to alert the user to the presence of important operating and maintenance (servicing) instructions in the literature accompanying the appliance.

WARNING:

TO REDUCE THE RISK OF FIRE OR ELECTRIC SHOCK, DO NOT EXPOSE THIS APPARATUS TO RAIN OR MOISTURE.

CAUTIONS

- This camcorder is designed to be used with NTSC-type color television signals. It cannot be used for playback with a television of a different standard. However, live recording and LCD monitor/viewfinder playback are possible anywhere.
- Use the JVC BN-V11U/V12U/V20U/V400U battery packs and, to recharge them or to supply power to the camcorder from an AC outlet, use the provided multi-voltage AC Adapter. (An appropriate conversion adapter may be necessary to accommodate different designs of AC outlets in different countries.)

NOTES:

- The rating plate (serial number plate) and safety caution are on the bottom and/or the back of the main unit.
- The rating information and safety caution of the AC Adapter are on its upper and lower sides.

ATTENTION:

The product that you have purchased is powered by a rechargeable battery. The battery is recyclable. At the end of its useful life, under various state and local laws, it may be illegal to dispose of this battery into the municipal waste stream. Check with your local solid waste officials for details in your area for recycling options or proper disposal.



Cassettes marked **SVHS** and **VHS** can be used with this camcorder.

The EPA certified RBRC® Battery Recycling Seal on the nickel-cadmium (Ni-Cd) battery indicates JVC is voluntarily participating in an industry program to collect and recycle these batteries at the end of their useful life, when taken out of service in the United States. The RBRC® program provides a convenient alternative to placing used Ni-Cd batteries into the trash or the municipal waste stream, which may be illegal in your area. Please call 1-800-8-BATTERY™ for information on Ni-Cd battery recycling and disposal bans/restrictions in your area. JVC's involvement in this program is part of our commitment to preserving our environment and conserving our natural resources.

When the equipment is installed in a cabinet or on a shelf, make sure that it has sufficient space on all sides to allow for ventilation (10 cm (3-15/16") or more on both sides, on top and at the rear).

Do not block the ventilation holes.

(If the ventilation holes are blocked by a newspaper, or cloth etc. the heat may not be able to get out.)

No naked flame sources, such as lighted candles, should be placed on the apparatus.

When discarding batteries, environmental problems must be considered and the local rules or laws governing the disposal of these batteries must be followed strictly.

The apparatus shall not be exposed to dripping or splashing.

Do not use this equipment in a bathroom or places with water.

Also do not place any containers filled with water or liquids (such as cosmetics or medicines, flower vases, potted plants, cups etc.) on top of this unit.

(If water or liquid is allowed to enter this equipment, fire or electric shock may be caused.)

IMPORTANT SAFETY INSTRUCTIONS

- (1)** Read these instructions.
- (2)** Keep these instructions.
- (3)** Heed all warnings.
- (4)** Follow all instructions.
- (5)** Do not use this apparatus near water.
- (6)** Clean only with dry cloth.
- (7)** Do not block any ventilation openings. Install in accordance with the manufacturer's instructions.
- (8)** Do not install near any heat sources such as radiators, heat registers, stoves, or other apparatus (including amplifiers) that produce heat.
- (9)** Only use attachments/accessories specified by the manufacturer.
- (10)** Use only with the cart, stand, tripod, bracket, or table specified by the manufacturer, or sold with the apparatus. When a cart is used, use caution when moving the cart/apparatus combination to avoid injury from tip-over.
- (11)** Unplug this apparatus during lightning storms or when unused for long periods of time.
- (12)** Refer all servicing to qualified service personnel. Servicing is required when the apparatus has been damaged in any way, such as power-supply cord or plug is damaged, liquid has been spilled or objects have fallen into the apparatus, the apparatus has been exposed to rain or moisture, does not operate normally, or has been dropped.



INDEX

A

AC Adapter	pg. 6
Animation Recording	pg. 21, 24
Audio Dubbing	pg. 24
Auto Date Record	pg. 19
Auto Focus	pg. 18
Auto Shut Off	pg. 11

B

Battery Pack	pg. 6, 26
Blue Filter Effect	pg. 23
Brighten The Image	pg. 18
Brighten The LCD Monitor	pg. 11

C

Cassette Adapter	pg. 16
Charge Marker	pg. 6
Charging The Battery Pack	pg. 6
Classic Film Effect	pg. 23
Clean The Camcorder	pg. 27
Connection To a VCR/TV	pg. 15
Connection To A PC	pg. 16
Counter Memory	pg. 14

D

Darken The Image	pg. 18
Darken The LCD Monitor	pg. 11
Date/Time Display	pg. 19
Date/Time Settings	pg. 7
Demonstration Mode	pg. 1, 21
Digital Effects	pg. 23
Digital Zoom	pg. 20
Diopter Adjustment	pg. 8

E

Electronic Fog Filter Mode	pg. 23
Erase Protection	pg. 8
Exposure Control	pg. 18

F

Fade-In/Out	pg. 22
Fast-Forward Tape	pg. 11

G

Grip Adjustment	pg. 8
-----------------------	-------

H

High Speed Shutter Mode	pg. 23
-------------------------------	--------

I

Insert Editing	pg. 24
Instant Titles	pg. 19

L

LCD Monitor/Viewfinder, Indications	pg. 9, 10, 17
Load A Tape	pg. 8

M

Manual Focus	pg. 18
Menu Screen	pg. 18 - 21
Monotone Effect	pg. 23
Mosaic Effect	pg. 23

N

ND Effect Mode	pg. 23
Nega/Posi Mode	pg. 23
Night-Alive	pg. 22

P

Picture Stabilizer	pg. 12
Playback	pg. 11
Playback Special Effects	pg. 14
Playback Zoom	pg. 24
Program AE with Special Effects	pg. 23
Provided Accessories	pg. 2

Q

Quick Review	pg. 13
--------------------	--------

R

Recording, Advanced Features	pg. 22, 23
Recording, Start/Stop	pg. 11
Recording Format (S-VHS/S-VHS ET)	pg. 20
Recording Mode	pg. 20
Record-Standby	pg. 11
Red Filter Effect	pg. 23
Remote Control	pg. 24
Retake	pg. 13
Rewind The Tape	pg. 11

S

Self-Recording	pg. 11
Sepia Mode	pg. 23
Shoulder Strap Attachment	pg. 8
Snapshot	pg. 12
Snapshot During Playback	pg. 12
Solarization Effect	pg. 23
Specifications	pg. 28
Sports Mode	pg. 23
Still Playback	pg. 11
Stretch Effect	pg. 23
Strobe Effect	pg. 23
Super LoLux (S.LX)	pg. 19
Super VHS Expansion Technology	pg. 20

T

Tape Counter	pg. 14
Tape Dubbing	pg. 15
Tape Length Setting	pg. 21
Tele Macro	pg. 21
Time Base Corrector	pg. 14
Time-Lapse Shooting	pg. 21, 24
Tracking	pg. 14
Tripod Mounting	pg. 8
Twilight Mode	pg. 23

U

Unload A Tape	pg. 8
---------------------	-------

V

Video Echo Effect	pg. 23
Video Light	pg. 13
Viewfinder Adjustment	pg. 8

W

White Balance Adjustment	pg. 19
Wide Mode	pg. 20
Wipe-In/Out	pg. 22

Z

Zooming	pg. 13
---------------	--------

GETTING STARTED

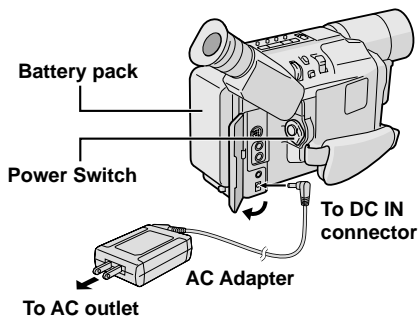
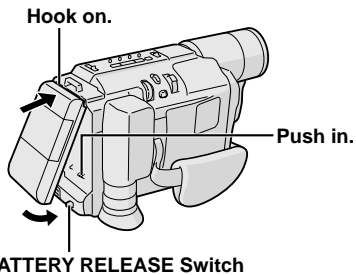

CHARGING THE BATTERY PACK

1) Hook the end of the battery pack to the camcorder and push the battery in until it locks in place.

• If the battery pack is attached in the wrong position, a malfunction may occur.

2) Set the Power Switch 12 to "OFF". Connect the AC Adapter to the DC IN connector 9.

3) Plug the AC Adapter into an AC outlet. The CHARGE lamp 18 blinks to indicate charging has started.

4) When the CHARGE lamp 18 stops blinking but stays lit, charging is finished. Unplug the AC Adapter from the AC outlet. Disconnect the AC Adapter from the camcorder.

To Detach The Battery Pack . . .

... slide BATTERY RELEASE 8 and pull out the battery pack.

Battery pack	Charging time
BN-V11U	approx. 1 hr. 30 min.
BN-V12U (optional)	approx. 1 hr. 30 min.
BN-V20U (optional)	approx. 2 hrs. 20 min.
BN-V400U (optional)	approx. 4 hrs. 30 min.

Charging times are for a fully discharged battery pack.

USING THE BATTERY PACK

Perform step 1) of "CHARGING THE BATTERY PACK".

Approximate recording time (unit: min.)

Battery pack	Viewfinder on	LCD monitor on
BN-V11U	95 (50)	80 (45)
BN-V12U (optional)	95 (50)	80 (45)
BN-V20U (optional)	150 (85)	135 (75)
BN-V400U (optional)	360 (205)	315 (190)

() : when the video light is on

USING AC POWER

Connect the AC Adapter to the camcorder (step 2) and 3) of "CHARGING THE BATTERY PACK".

• The provided AC Adapter features automatic voltage selection in the AC range from 110 V to 240 V.

ATTENTION

Before detaching the power source, make sure that the camcorder's power is turned off. Failure to do so can result in a camcorder malfunction.

REFRESH:

Be sure to fully discharge a battery pack before recharging or storing it for a long period of time, otherwise the battery performance will be reduced.

- 1) Perform steps 1) through 3) of "CHARGING THE BATTERY PACK".
- 2) Press REFRESH 24 for over 2 seconds. The REFRESH lamp 19 blinks to indicate discharging has started.
- 3) When discharging is finished, charging automatically starts and the CHARGE lamp 18 blinks.

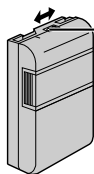

Charge marker helps you remember whether the battery pack has been charged or not. Two colors are provided (red and black)—you choose which one means charged and which means discharged.

- During charging or discharging, the camcorder cannot be operated.
- Charging and discharging is not possible if the wrong type of battery is used.
- When charging the battery pack for the first time or after a long storage period, the CHARGE lamp **(B)** may not light. Remove the battery pack from the camcorder, then try charging again.
- If a fully-charged battery's operation time remains extremely short, the battery is worn out. Please purchase a new one.
- Perform charging where the temperature is between 10°C and 35°C (50°F and 95°F). 20°C to 25°C (68°F to 77°F) is the ideal temperature range for charging. If the environment is too cold, charging may be incomplete.
- Charging time varies according to the ambient temperature and the status of the battery pack.
- Since the AC Adapter processes electricity internally, it becomes warm during use. Be sure to use it only in well-ventilated areas.
- The following operation stops charging or discharging:
 - Set the Power Switch **(12)** to "PLAY", "A" or "M".
 - Disconnect the AC Adapter from the camcorder.
 - Unplug the AC Adapter from the AC outlet.
 - Detach the battery from the camcorder.
- Using the optional AA-V15 AC Power Adapter/Charger, you can charge the BN-V11U/V12U/V20U/V400U battery pack without the camcorder. However, it cannot be used as an AC adapter.
- To avoid interference with reception, do not use the AC Adapter near a radio.
- Recording time is reduced significantly when Zoom or Record-Standby mode is engaged repeatedly or the LCD monitor is used repeatedly.
- Before extended use, it is recommended that you prepare enough battery packs to cover 3 times the planned shooting time.

Date/Time Settings

- 1) Set the Power Switch **(12)** to "M".
- 2) Press the MENU Wheel **(1)** in. The Menu Screen appears.
- 3) Rotate the MENU Wheel **(1)** to select "▶ TO SYSTEM MENU" and press it to display SYSTEM MENU. Rotate the MENU Wheel **(1)** to select "▶ NEXT" and press it to display the next page.
- 4) Rotate the MENU Wheel **(1)** to select "DATE/TIME" and press it. The DATE/TIME Menu appears.
- 5) To set "YEAR", "MONTH", "DAY" or "TIME" (hour/minute), rotate the MENU Wheel **(1)** to select the desired item, and press it. When the setting begins blinking, rotate the MENU Wheel **(1)** until the correct setting appears and then press it. The setting stops blinking.
- 6) When none of these settings ("YEAR", "MONTH", "DAY", "TIME") blinks, rotate the MENU Wheel **(1)** to select "EXIT", and press it. The Menu Screen reappears with the highlight bar on "▶ RETURN".
- 7) Press the MENU Wheel **(1)** in to close the Menu Screen.
 - To display the date and time in the camcorder's display and on a connected TV, see DATE/TIME DISP. (▶ pg. 19) in CAMERA MENU.
 - The date/time cannot be stored in memory if the built-in clock battery runs out. Consult an authorized JVC dealer for replacement, or set the date/time as necessary before you start shooting.

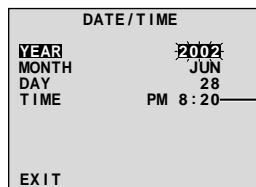
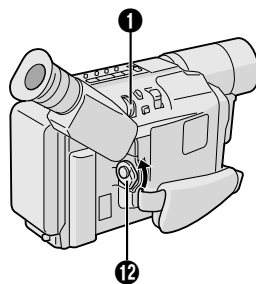

12-hour indication with AM or PM

Grip Adjustment

- 1) Separate the Velcro strip.
- 2) Pass your right hand through the loop and grasp the grip.
- 3) Adjust so that your thumb and fingers can easily operate the Recording Start/Stop Button **11** and Power Zoom Lever **3**. Refasten the Velcro strip.

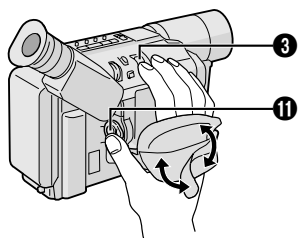

Viewfinder Adjustment

- 1) Set the Power Switch **12** to "A" or "M".
- 2) Turn the Diopter Adjustment Control **29** until the indications in the viewfinder are clearly focused.

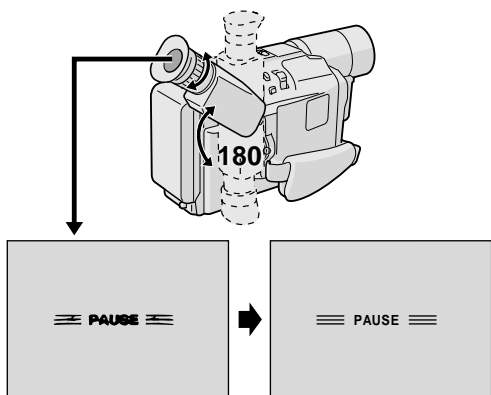

Shoulder Strap Attachment

Thread the strap through the eyelet **26**, then fold it back and thread it through the buckle. Repeat the procedure to attach the other end of the strap to the other eyelet **26**, making sure the strap is not twisted. Adjust the length.

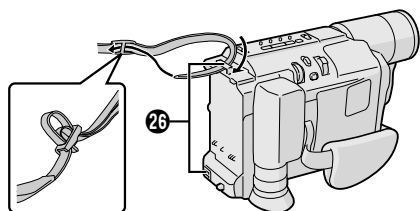

Tripod Mounting

Align the screw and camera direction stud on the tripod with the tripod mounting socket **42**. Then tighten the screw.

CAUTION

When using a tripod, be sure to open and extend its legs fully to stabilize the camcorder. To prevent damage to the unit caused by falling over, do not use a small-sized tripod.

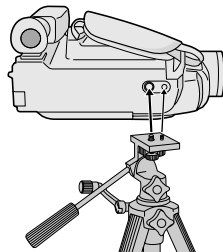

Loading/Unloading A Cassette

- 1) Open the LCD monitor fully. Slide EJECT **25** until the cassette holder opens. Do not use force to open.
 - 2) Insert or remove a cassette. When inserting, make sure the label is facing outward. **21** appears when a cassette is loaded.
 - 3) Press the Close button **28** to close the cassette holder until it locks into place. Close the LCD monitor.
- Closing the LCD monitor while the cassette holder is still open may cause damage to the LCD monitor.
 - Make sure the erase protection tab is in the position that allows recording. If not, slide the tab. Some cassettes have removable tabs. If the tab has been removed, cover the hole with adhesive tape.
 - The cassette holder cannot be opened while the camcorder is in the record mode or detached from the power source.

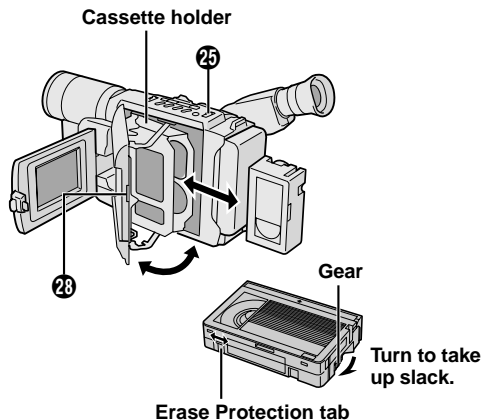

CONTROLS, CONNECTORS AND INDICATORS

Refer to this diagram while reading the instructions.

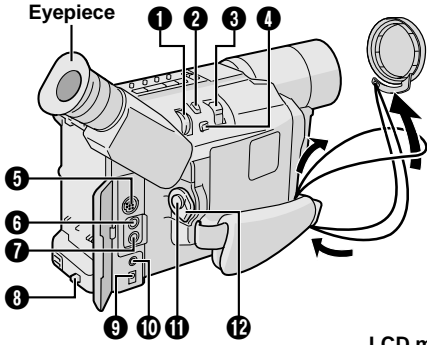

During shooting

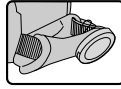

Keep the lens cap attached to the camcorder.

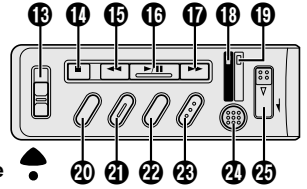

Cassette holder

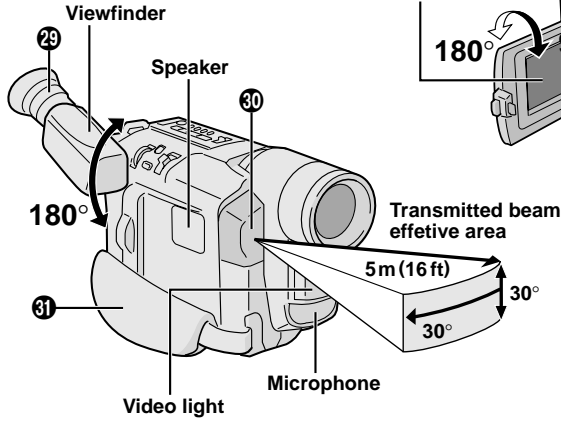

LCD monitor

180°

90°

Turn the gear to take up slack.

Erase protection tab

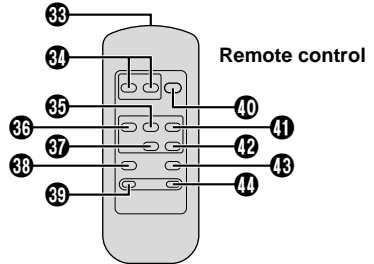

LCD Monitor/Viewfinder Indications

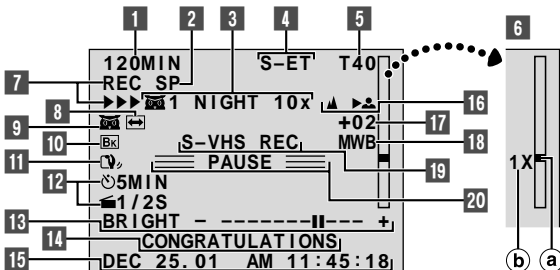

During Recording

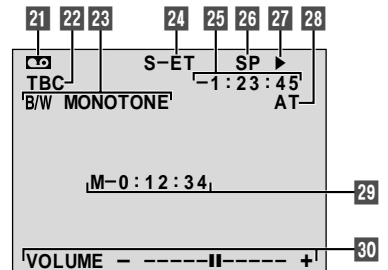

During Playback



pg. 25 for **Warning Indications**.

1	• MENU Wheel [-, +]	pg. 18	39	• REC TIME Button	pg. 24
	• BRIGHT Wheel [-, +]	pg. 11		• ANIM. Button	pg. 24
	• TRACKING Wheel [-, +]	pg. 14	40	START/STOP Button (Functions the same as 10)	
2	Snapshot Button [SNAPSHOT]	pg. 12	41	FF Button (Functions the same as 17)	
3	• Power Zoom Lever [T/W]	pg. 13	42	PAUSE Button	pg. 11
	• Speaker Volume Control [VOL.]	pg. 11	43	A.DUB Button	pg. 24
4	• Picture Stabilizer Button [P.STABILIZER]	pg. 12	44	• INT.TIME Button	pg. 24
	• Time Base Corrector Button [TBC]	pg. 14		• SELF TIMER Button (non-functional)	
5	S-Video Output Connectors [S]	pg. 15	1	Tape Remaining Time	pg. 21
6	Audio Output Connector [A]	pg. 15	2	Recording Mode Indicator	pg. 20
7	Video Output Connector [V]	pg. 15	3	• Digital Effect Indicator	pg. 23
8	Battery Release Switch [BATTERY RELEASE]	pg. 6		• Program AE Indicator	pg. 23
9	DC IN Connector	pg. 6		• Night-Alive Indicator	pg. 22
10	Digital Connector [DIGITAL]			• Fade/Wipe-Standby Indicator	pg. 22
11	Recording Start/Stop Button	pg. 11	4	Recording Format Indicator (S/S-ET)	pg. 20
12	Power Switch [PLAY, OFF, A, M]	pg. 11	5	Tape Length Indicator	pg. 21
13	Video Light Switch [LIGHT OFF/AUTO/ON]	pg. 13	6	Zoom Indicator Bar	pg. 13
14	Stop Button [STOP]	pg. 11		Ⓐ Zoom Level Indicator	
15	• Retake Rewind Button [RETAKE R]	pg. 13		Ⓑ Approximate Zoom Ratio	
	• Quick Review Button [C R]	pg. 13	7	Recording Indicator	pg. 11
	• Rewind Button [R]	pg. 11	8	Digital Effect Indicator	pg. 23
16	Play/Pause Button	pg. 11	9	• Program AE Indicator	pg. 23
17	• Retake Forward Button [RETAKE F]	pg. 13		• Night-Alive Indicator	pg. 22
	• Fast-Forward Button [F]	pg. 11	10	Fade/Wipe-Standby Indicator	pg. 22
18	CHARGE Lamp	pg. 6	11	Picture Stabilizer Indicator	pg. 12
19	POWER/REFRESH Lamp	pg. 6	12	Interval Time/Recording Time Indicator	pg. 21
20	• Fade/Wipe Button [FADE/WIPE]	pg. 22	13	Bright Level Indicator	pg. 11
	• Counter Reset/Memory Button [COUNTER R/M]	pg. 14	14	Instant Title Display	pg. 19
21	Program AE Button [P.AE]	pg. 23	15	Date/Time Display	pg. 19
22	Digital Effect Button [DIGIEFFECT]	pg. 23	16	Focus Indicator	pg. 18
23	NIGHT-ALIVE Button	pg. 22	17	Exposure Control Level Counter	pg. 18
24	REFRESH Button	pg. 6	18	White Balance Mode Indicator	pg. 19
25	EJECT Switch	pg. 8	19	S-VHS/S-VHS ET Recording Indicator	pg. 20
26	Shoulder Strap Eyelets	pg. 8	20	Record-Standby Mode Indicator	pg. 11
27	Battery Pack Mount	pg. 6	21	•  : Cassette Indicator	pg. 8
28	Close Button	pg. 8		•  : Insert Editing Indicator	pg. 24
29	Diopter Adjustment Control	pg. 8	22	TBC Indicator	pg. 14
30	• Camera Sensor Be careful not to cover this area; a sensor necessary for shooting is built-in here.		23	Playback Special Effect Indicator	pg. 14
	• Remote Sensor	pg. 9, 17	24	Recording Format Indicator (S/S-ET)	pg. 20
31	Grip Strap	pg. 8	25	Tape Counter	pg. 14, 24
32	Tripod Mounting Socket	pg. 8	26	Recording Mode Indicator (SP/EP)	pg. 20
33	Infrared Beam Transmitting Window	pg. 9, 17	27	Tape Running Indicator	
34	ZOOM (T/W) Buttons	pg. 13, 24		▶ : Playback	
35	PLAY Button	pg. 11		▶▶ : Fast-Forward/Shuttle Search	
36	REW Button (Functions the same as 15)			◀◀ : Rewind/Shuttle Search	
37	STOP Button (Functions the same as 14)			: Pause	
38	INSERT Button	pg. 24		▶◀ : Audio Dubbing	
			28	Tracking Indicator	pg. 14
			29	Tape Counter	pg. 24
			30	• BRIGHT: Bright Level Indicator	pg. 11
				• VOLUME: Speaker Volume Indicator	pg. 11

RECORDING

Set REC MODE, S-VHS (S-VHS ET), TAPE LENGTH and DATE/TIME in SYSTEM MENU. (☞ pg. 18 – 21, “MENU SETTINGS”)

1 Remove the lens cap. Set the Power Switch 12 to “A” or “M”.

Shooting while using the viewfinder: Make sure the LCD monitor is closed and locked.

Shooting while using the LCD monitor: Make sure the LCD monitor is fully open.

The camcorder enters the Record-Standby mode and “PAUSE” 20 is displayed.

- If you tilt the LCD monitor upward to 180 degrees, the viewfinder switches back on and the monitored image can be viewed both on the LCD monitor and in the viewfinder, so the person you shoot can view himself/herself.

2 Press the Recording Start/Stop Button 11. REC 7 appears while recording is in progress.

- To stop recording, press the Recording Start/Stop Button 11. The camcorder re-enters the Record-Standby mode.

To Adjust The Brightness Of The LCD Monitor, rotate the BRIGHT Wheel 1 until the bright level indicator 13 on the display moves and the appropriate brightness is reached.

- Tapes recorded on S-VHS or S-VHS ET (☞ pg. 18, 20) cannot be played back correctly on a normal VHS VCR. To playback on a regular VHS VCR, use a VHS tape and select S-VHS ET (OFF) in SYSTEM MENU (☞ pg. 18, 20).

PLAYBACK

1 Load a tape (☞ pg. 8, “Loading/Unloading A Cassette”).

2 Set the Power Switch 12 to “PLAY”. To start playback, press ►/II 16 or 65.

To stop playback temporarily (Still Playback), press ►/II 16 or 12. To stop playback, press ■ 14. Press ◀◀ 15 to rewind, or ▶▶ 17 to fast-forward the tape.

High-speed picture search (Shuttle Search) is possible by pressing ◀◀ 15 or ▶▶ 17 during playback (holding ◀◀ 15 or ▶▶ 17 down during playback continues search until released). To resume normal playback, press ►/II 16 or 65.

For VIDEO RECORDING/VIDEO PLAYBACK

- The camcorder shuts off automatically after about 5 minutes in the Record-Standby or Stop mode. To turn on again, set the Power Switch 12 to “OFF”, then to “A”, “M” or “PLAY”.
- When the Power Switch 12 is set to “A”, “M” or “PLAY” and the LCD monitor* is opened at an angle of 60 degrees or more, the LCD monitor switches on and the viewfinder switches off automatically to save power.
- The playback picture can be viewed in the viewfinder (with the LCD monitor shut), on the LCD monitor or on a connected TV (☞ pg. 15, “Connections To A TV/VCR”).
- To remove the indications, ☞ pg. 21, DISPLAY or OSD OUTPUT in SYSTEM MENU.
- To control the speaker volume, slide VOL. 3 towards “+” to turn up, or towards “-” to turn down. While shooting, sound is not heard from the speaker.
- If TBC (☞ pg. 14) is engaged during Still Playback, noise bars will not appear.

BASIC FEATURES

Snapshot

You can record still images that look like photographs onto a tape.

1) Perform step 1 of "RECORDING" (☞ pg. 11).

2) Press SNAPSHOT **2**.

- There is a momentary camera shutter-type blackout together with the sound effect of a shutter closing.
- Snapshot is also available during playback. However, the shutter sound is not heard.

Picture Stabilizer

To compensate for unstable images caused by camera-shake, particularly at high magnification.

1) Press P. STABILIZER **4**. **4**, **11** appears.

2) To switch off the Picture Stabilizer, press P. STABILIZER **4**. **4**, **11** disappears.

- Accurate stabilization may not be possible in certain conditions including excessive hand shake.
- **4**, **11** appears blinking if the Stabilizer cannot be used.
- This function cannot be activated during the "Night-Alive", "CLASSIC FILM", "STROBE" and "VIDEO ECHO" modes (☞ pg. 23, "Digital Effects").

Zooming

To produce the zoom in/out effect. Digital circuitry extends the maximum magnification offered by optical zoom. This system is called Digital Zoom.

- Slide the Power Zoom Lever **3** towards "T" to zoom in, or "W" to zoom out.
- The further you slide the Power Zoom Lever **3**, the quicker the zoom action.
- Focusing may become unstable during Zooming. In this case, set the zoom while in Record–Standby, lock the focus by using the manual focus (ⓘ pg. 18, FOCUS in CAMERA MENU), then zoom in or out in Record mode.
- The zoom level indicator **6**-**ⓐ** moves during zoom. Once the zoom level indicator **6**-**ⓐ** reaches the top, all magnification from that point is through digital processing.
- When using Digital Zoom, the quality of image may suffer. To deactivate Digital Zoom, set "D.ZOOM" (ⓘ pg. 20) to "OFF" in SYSTEM MENU.
- Digital zoom cannot be used when the "VIDEO ECHO" mode (ⓘ pg. 23, "Digital Effects") is activated.

Video Light



To brighten the scene when natural lighting is too dim.

Set LIGHT OFF/AUTO/ON **13** as required:

OFF : Turns off the light.

AUTO: Automatically turns on the light when the camcorder senses insufficient lighting on the subject.

ON : Always keeps the light on as long as the camcorder is turned on.

- It is recommended to set M.W.B. (ⓘ pg. 19) to  in CAMERA MENU when you use the video light.
- Even if the battery indicator () does not blink if the battery pack's charge is low, the camcorder may turn off automatically when you turn on the video light, or when you start recording with the video light turned on.
- When LIGHT OFF/AUTO/ON **13** is set to "AUTO":
 - Depending on the lighting conditions, the video light may keep turning on and off. Set LIGHT OFF/AUTO/ON **13** to ON or OFF as required.
 - While the "Sports" or "High Speed Shutter" mode is engaged, the light is likely to stay on. While the "Twilight" mode is engaged, the light will not activate. (ⓘ pg. 23, "Program AE with Special Effects")

DANGER



- The video light can become extremely hot.
Do not touch it either while in operation or soon after turning it off, otherwise serious injury may result.
- Do not place the camcorder into the carrying case immediately after using the video light, since it remains extremely hot for some time.
- When operating, keep a distance of about 30 cm (11-13/16") between the video light and people or objects.
- Do not use near flammable or explosive materials.
- It is recommended that you consult your nearest JVC dealer for replacing the video light.

Quick Review

To check the end of the last recording.

- 1) Make sure the camcorder is in the Record–Standby mode.
- 2) Press **◀ 15** and release quickly.
Tape is rewound for approx. 2 seconds and played back automatically, then pauses in Record–Standby mode for the next shot.
- Distortion may occur at the start of playback. This is normal.

Retake

To re-record certain segments.

- 1) Make sure the camcorder is in the Record–Standby mode.
- 2) Press and hold either RETAKE **16** or **17** to reach the start point for new recording. Pressing **▶▶ 17** forwards the tape and pressing **◀◀ 16** reverses it.
- 3) Press the Recording Start/Stop Button **11** to start recording.
- Noise bars appear and pictures may become monochrome or darken during Retake. This is normal.

Tracking

Eliminates noise bars that appear on-screen during playback. To activate Manual Tracking:

- 1) Press the TRACKING Wheel **1** for approx. 2 seconds. "MT" **28** appears.
 - 2) Rotate the TRACKING Wheel **1** so that the noise bars disappear.
- To return to Auto Tracking, press the TRACKING Wheel **1** for approx. 2 seconds or set the Power Switch **12** to "OFF" and then "**PLAY**" again. "AT" **28** blinks. When Auto Tracking finishes, the indication disappears.
 - When noise bars appear during playback, the camcorder enters the Auto Tracking mode and "AT" **28** appears.
 - Manual Tracking may not work with tapes recorded on other VCRs or camcorders.

TBC (Time Base Corrector)

Removes jitter from fluctuating video signals to deliver a stable picture even with old tapes.

To activate/release the TBC mode, press TBC **4** during playback for more than 1 second. When the TBC mode is activated, "TBC" **22** is displayed.

- The "TBC" indicator **22** turns green (gray with a camcorder equipped with a black/white viewfinder) while TBC is working, and white while TBC is not operative.
- TBC does not work during Still Playback and Shuttle Search (**13** pg. 11).
- It may take a few seconds before TBC actually starts working.
- The picture may be distorted if the TBC mode is activated or deactivated at the edit-in/-out points or when normal playback resumes after Still Playback or Shuttle Search (**13** pg. 11).
- If the playback picture is distorted when TBC is set to on, turn off TBC.

Counter Memory

Makes it easier to locate a specific tape segment.

- 1) Press COUNTER R/M **20** and hold for more than 1 second. The counter **25** resets to "0:00:00".
 - 2) Press COUNTER R/M **20** for less than 1 second. "M" appears.
 - 3) After recording or playback, press **■ 14**, then **◀◀ 15**. The tape automatically stops at or close to 0:00:00.
 - 4) Press **▶/II 16** to start playback.
- The counter memory functions in the Fast-Forward and Rewind modes.
 - To disable the counter memory function, press COUNTER R/M **20** for less than 1 second so that "M" disappears.

Playback Special Effects

Allows you to add creative effects to the playback image. (**13** pg. 23, "Digital Effects")

- 1) Activate "TBC" and Auto "Tracking".
 - 2) Press DIGIFECT **22** repeatedly until the desired mode **23** appears.
- To cancel the effect, select "OFF".
 - NEGA POSI, MOSAIC and STRETCH are not available.
 - Playback Special Effects do not work during Shuttle Search (**13** pg. 11).
 - The selected effect mode cannot be changed during Still Playback (**13** pg. 11).

Connections To A TV/VCR

- 1) Make sure all units are turned off.
- 2) Connect the camcorder to a TV or VCR using optional video and audio cables. If using both TV and VCR, connect the VCR output to the TV input.
- 3) Turn on all units. Set the VCR to its AUX input mode, and set the TV to its VIDEO mode.
 - Use the AC Adapter as the power supply.
 - The S-Video cable connection can improve the dubbed picture quality. **The S-Video cable is optional. Be sure to use the following cable: YTU94146A S-Video cable.** Consult the JVC Service Center described on the sheet included in the package for details on its availability. Make sure to connect the end with a core filter to the camcorder. The core filter reduces interference.
 - Be sure to adjust the TV sound volume to its minimum level to avoid a sudden burst of sound when the camcorder is turned on.
 - If you have a TV or speakers that are not specially shielded, do not place the speakers adjacent to the TV as interference will occur in the camcorder playback picture.

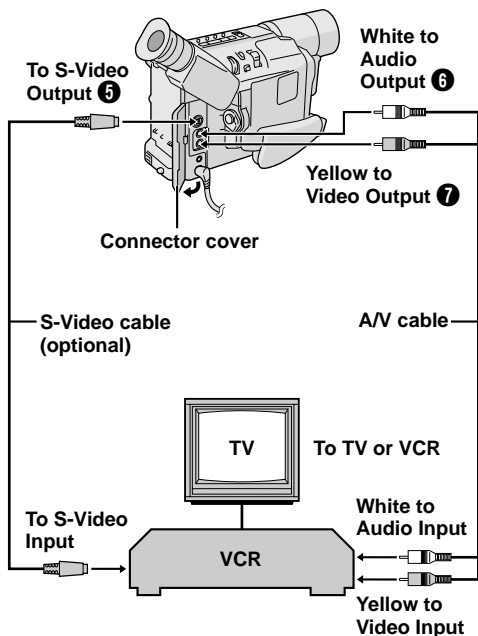

Tape Dubbing

- 1) Connect the camcorder and the VCR (☞ “Connections To A TV/VCR”). Set the Power Switch (12) to “PLAY”, turn on the VCR’s power, and insert the appropriate cassettes in the camcorder and the VCR. Engage the VCR’s AUX and Record-Pause modes.
- 2) Press ►/|| (16) to find a spot just before the edit-in point. Once it is reached, press ►/|| (16) again.
- 3) Press ►/|| (16) and engage the VCR’s Record mode.
- 4) Engage the VCR’s Record-Pause mode and press ►/|| (16).
 - Repeat steps 2) through 4) for additional editing, then stop the VCR and camcorder when finished.

Using The Cassette Adapter

Use this to play back an S-VHS-C/VHS-C video cassette recorded with this camcorder on a S-VHS/VHS VCR.

- 1) Slide the battery cover up to remove it, install one "AA (R6)" size battery, then reattach the cover.
 - 2) Slide the latch to open the compartment door, then insert the cassette and close the compartment door.
 - 3) Load the cassette adapter into the VCR and play the tape back.
 - 4) Slide the latch and the compartment door opens automatically. This may take around 10 seconds. Do not attempt to force the adapter open. Then, insert your finger in the hole, and push up and remove the cassette.
- During tape loading and unloading, do not touch the reels for safety and tape protection.
 - Tapes recorded in S-VHS or S-VHS ET mode cannot be played back on a regular VHS VCR. Playback is possible with a VCR equipped with the S-VHS or SQPB (S-VHS QUASI PLAYBACK) function.
 - During special-effect playback (slow motion, still frame, etc.), the picture may vibrate or noise bars may appear on the screen.
 - To record on a VCR using a compact cassette and the adapter, cover the adapter's recording safety hole with adhesive tape.

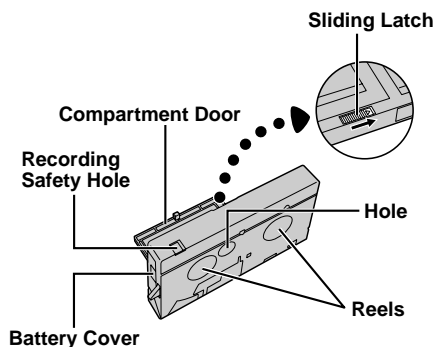

Connection To A Personal Computer

You can transfer image data from the camcorder to a PC using Digital Photo Navigator. When connecting to your PC, refer to the instruction manuals of the PC and Setup Guide for the provided software.

When connecting to a Macintosh . . .

The optional KEYSpan USA-19 USB PDA Adapter is required.

- Macintosh is a registered trademark of Apple Computer, Inc.
- Keyspan is a trademark of InnoSys Inc.

INSTRUCTIONS

Refer to this diagram while reading the instructions.

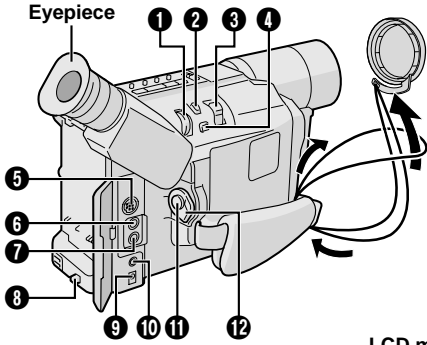

During shooting

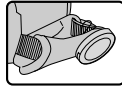

Keep the lens cap attached to the camcorder.

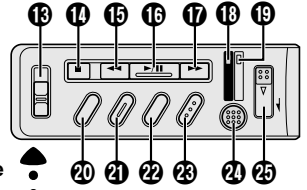

Cassette holder

Turn the gear to take up slack.

LCD monitor

180°

90°

28

26

Erase protection tab

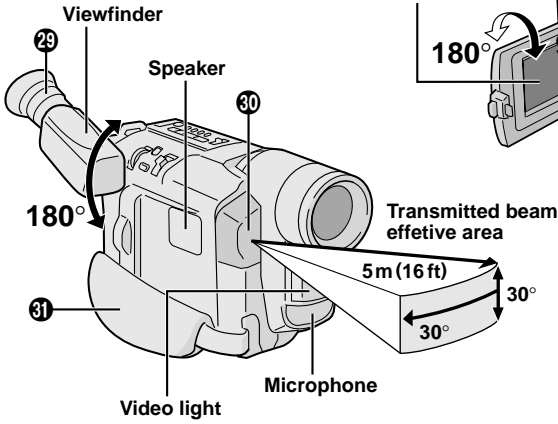

Transmitted beam effective area

5m (16ft)

30°

30°

Video light

Microphone

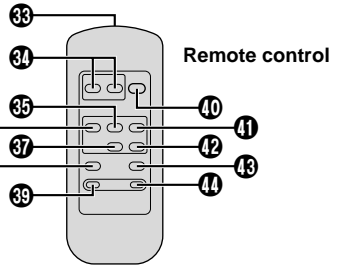

Remote control

LCD Monitor/Viewfinder Indications

During Recording

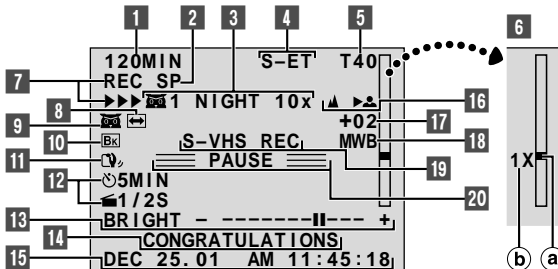

During Playback

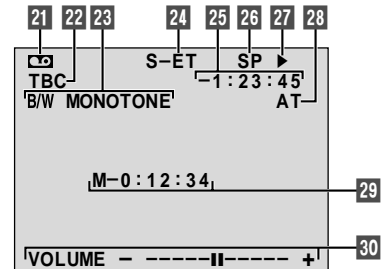

pg. 25 for **Warning Indications**

MENU SETTINGS

1 Set the Power Switch **12** to “**M**”.

2 Press the MENU Wheel **1** in. The Menu Screen appears. Rotate the MENU Wheel **1** to select the desired function.

- To go from CAMERA MENU to SYSTEM MENU, rotate the MENU Wheel **1** to select “▶TO SYSTEM MENU” and press it. SYSTEM MENU is composed of 2 pages. To go to the next page, rotate the MENU Wheel **1** to select “▶NEXT” and press it.
- To return to CAMERA MENU from page 2 of SYSTEM MENU, rotate the MENU Wheel **1** to select “▶TO CAMERA MENU” and press it.

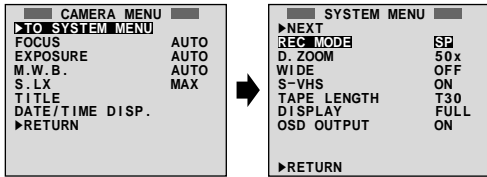

3 Press the MENU Wheel **1** in to display the Setting Menu and rotate it to select the desired setting.

4 Press the MENU Wheel **1** in. The Menu Screen reappears with the highlight bar on “▶RETURN”. Press the MENU Wheel **1** in. The normal screen reappears.

CAMERA MENU

FOCUS

If correct focus cannot be obtained with AUTO FOCUS, set to MANU to use manual focusing. “▲▲” appears.

To focus on a farther subject, rotate the MENU Wheel **1** upward. “◀” appears and blinks.

To focus on a nearer subject, rotate the MENU Wheel **1** downward. “▶” appears and blinking.

- If the lens is smeared or blurred, accurate focusing is not possible.
- When shooting a subject close to the lens, zoom out first (☞ pg. 13, “Zooming”). If zoomed in in the auto focus mode, the camcorder could automatically zoom out depending on the distance between the camcorder and the subject. This does not occur with “TELE MACRO” (☞ pg. 21) in SYSTEM MENU.

- Be sure to focus the lens in the maximum telephoto position when you use the Manual Focus mode. If you focus in on a certain subject in the wide-angle position, sharply focused images cannot be obtained when zoomed in because the depth-of-field is reduced at longer focal lengths.
- When the focus level cannot be adjusted any farther or closer, “▲” or “▲” will blink.

EXPOSURE

Manual exposure adjustment is recommended in the following situations:

- When shooting using reverse lighting or when the background is too bright.
- When shooting on a reflective natural background such as at the beach or when skiing.
- When the background is overly dark or the subject light.

To brighten the image, rotate the MENU Wheel **1** downward.

To darken the image, rotate the MENU Wheel **1** upward.

The exposure control level increases/decreases (maximum ±06).

M.W.B.



If the white balance is correct, all other colors will be accurately reproduced.

AUTO : White balance is adjusted automatically.

 **FINE** : Outdoors on a sunny day.

 **CLOUD** : Outdoors on a cloudy day.

 **HALOGEN** : A video light or similar type of lighting is used.

MWB: White balance is set manually. Hold a sheet of plain white paper in front of the subject. Adjust zoom or position yourself so that the white paper fills the screen. If it is difficult to focus on the white paper, adjust focus manually ( FOCUS in CAMERA MENU). Press the MENU Wheel  in until "MWB" begins blinking. When the setting is completed, "MWB" stops blinking.

- Once you adjust white balance manually, the setting is retained even if the power is turned off or the battery removed.

- White balance cannot be used when the "SEPIA" or "MONOTONE" mode ( pg. 23, "Digital Effects") is activated.

S.LX

MAX: To record a subject in a darkly lit environment, when it is more convenient to shoot the subject with a brighter image even if the picture becomes slightly coarse.

NORMAL: To record a subject in a dimly lit environment, when it is more convenient to shoot with a less coarse picture although the subject becomes slightly dark. This setting is suitable for measuring sensitivity conforming to EIA-639 (EIA* Standard for Low Light Sensitivity Measurement).

* EIA : Electronic Industries Alliance

OFF: Allows you to shoot dark scenes with no picture brightness adjustment.

TITLE

Allows you to superimpose one of eight preset titles in 2 different languages. Change the language in TITLE LANG. ( pg. 21) in SYSTEM MENU.

-  shows the selected title which remains until OFF is selected.

DATE/TIME DISP.

Makes the date/time appear in the camcorder or on a connected monitor (set DATE/TIME in SYSTEM MENU first  pg. 7).

- The selected display will be recorded. If you do not want to record the display, select OFF before shooting.

- In the AUTO DATE mode, the camcorder records the date for about 5 seconds when recording is initiated after the date is changed, a cassette is loaded, or AUTO DATE is selected. The date is replaced after 5 seconds with "AUTO DATE" but this is not recorded.

SYSTEM MENU

This Menu Screen cannot be accessed while recording.

REC MODE

Allows you to set the recording mode. "EP" (Extended Play) is more economical, providing three times the recording time.

- If the recording mode is switched during recording, the playback picture will be blurred at the switching point.

D. ZOOM

Zooming is possible from 16X (the optical zoom limit), to a maximum of 50X or 600X digital magnification.

When set to "OFF" only optical zoom (maximum 16x magnification) can function.

WIDE

When set to "ON" black bars will be recorded at the top and bottom of the screen to produce a cinema-like "wide-screen" effect. Not effective with "Snapshot" (📷 pg. 12).

S-VHS (S-VHS ET)

ON: With an S-VHS cassette, "S" appears and the camcorder records in S-VHS.

With a VHS cassette, "S-ET" appears and the camcorder records with S-VHS picture quality, which is called Super VHS ET (Expansion Technology). S-VHS REC appears during recording.

OFF: Records in VHS on a VHS or S-VHS cassette.

- JVC EHG (Extra High Grade) tapes are recommended for superior results.
Use S-VHS tape for storing recordings for an extended period or for recording important scenes, as it enables higher-quality recording and playback.
- With some tapes, better picture quality may not be obtained even with S-VHS ET recording. It is recommended that you do test record beforehand to make sure whether better results can be obtained.
- If the S-VHS ET mode or recording format is switched during recording, the playback picture will be blurred at the switching point.
- It is recommended that tapes recorded on this camcorder be played back on this camcorder.

- Tapes recorded in S-VHS or S-VHS ET mode can be played back not only on this camcorder but also on a Super VHS VCR or a VCR equipped with the SQPB (S-VHS QUASI PLAYBACK) function.

- When tapes recorded in S-VHS or S-VHS ET mode are played back on a VCR equipped with the SQPB (S-VHS QUASI PLAYBACK) function, S-VHS picture quality is not available.
- Tapes recorded in S-VHS ET mode cannot be played back on some VCRs, including some JVC VCRs.

- Tapes recorded in S-VHS or S-VHS ET mode cannot be played back correctly on a normal VHS VCR.
- S-VHS ET does not work with S-VHS tapes.
- To avoid on-screen noise, do not perform Still Playback or Shuttle Search repeatedly.
- If the picture contains a lot of jitter or noise, use a cleaning cassette.

TAPE LENGTH

Allows you to set the tape length depending on the tape used: T20=20 minutes, T30=30 minutes, T35=35 minutes, T40=40 minutes.

- Tape remaining time **1** is correct only if the correct tape length has been selected.

DISPLAY

FULL: Makes all of the indications appear on the LCD monitor/viewfinder during playback or recording.

SIMPLE: Makes the following indications disappear from the LCD monitor/viewfinder during recording or playback: **93**, tape remaining time, **94**, tape length (☞ pg. 9, 17).

OSD OUTPUT

ON: On-screen indications are displayed.

OFF: On-screen indications are turned off except Date/Time, Instant Title and Warning Indication.

REC TIME

You can shoot a series of pictures, each slightly different, of the same object for a brief selected period of time (Animation). REC MODE should be set to "SP".

Select the desired recording time and press the Recording Start/Stop Button **1** after focusing on the subject.

- The remote control can also be used for this setting. (☞ pg. 24, "Animation And Time-Lapse")
- Fade- or wipe-in/out cannot be performed.
- This function is canceled when the power is shut off or when the cassette is ejected.

INT. TIME

You can record sequentially at preset time spans. Leaving the camcorder aimed at a specific subject, you can record subtle changes over an extended period of time (Time-Lapse). REC MODE should be set to "SP".

Select the desired interval time and press the Recording Start/Stop Button **1**.

- The remote control can also be used for this setting. (☞ pg. 24, "Animation And Time-Lapse")
- Fade- or wipe-in/out cannot be performed.
- This function is canceled when the power is shut off or when the cassette is ejected.

TELE MACRO

When set to "ON", you can shoot a subject as large as possible at a distance of approx. 60 cm (23-5/8").

Depending on the zoom position, the lens may go out of focus.

TITLE LANG.

Allows you to select the language (ENGLISH, FRENCH, SPANISH or PORTUGUESE) of TITLE in CAMERA MENU. After selection, the TITLE setting menu (☞ p. 19) appears automatically.

DATE/TIME

Allows you to set the current date and time. (☞ pg. 7)

DEMO MODE

Demonstrates certain functions automatically. Available when the Power Switch **12** is set to "A" or "M" and "DEMO MODE" is set to "ON" (factory-preset). Performing any operation during the demonstration stops the demonstration temporarily. Set to OFF to stop completely.

- When a tape whose erase protection tab is in the position that allows recording is loaded in the camcorder, demonstration is not available.
- If you do not detach the Lens Cap, you cannot see the actual changes of the Automatic Demonstration activated on the LCD monitor or viewfinder.

Night-Alive

Makes dark subjects or areas even brighter than they would be under good natural lighting.

- 1) Set the Power Switch **12** to “**A**” or “**M**”.
- 2) Press NIGHT-ALIVE **28** repeatedly until the desired mode appears.

☞ A NIGHT AUTO: The shutter speed is automatically adjusted (maximum 1/6 sec.).

☞ 1 NIGHT 10X (only when the Power Switch **12** is set to “**M**”): The shutter speed is set to 1/6th of a second to provide 10 times the sensitivity.

☞ 2 NIGHT 60X (only when the Power Switch **12** is set to “**M**”): The shutter speed is set to 1 second to provide 60 times the sensitivity.

- To cancel the effect, press NIGHT-ALIVE **28** repeatedly until “OFF” appears.
- During Night-Alive, the following cannot be activated: “Picture Stabilizer”, “Program AE With Special Effects”, “Digital Effects” and “S.LX” in CAMERA MENU (☞ pg. 19).
- Night-Alive does not work when LIGHT OFF/AUTO/ON **13** is set to “AUTO” or “ON” (☞ pg. 13, “Video Light”).
- During Night-Alive, it may be difficult to bring the camcorder into focus. To prevent this, use of a tripod is recommended.

Fade/Wipe Effects

Fade- or wipe-in works at recording start, and fade- or wipe-out works at recording end.

- 1) Set the Power Switch **12** to “**M**”.
 - 2) Press FADE/WIPE **20** repeatedly until the desired mode appears.
 - 3) Press the Recording Start/Stop Button **11** to activate fade-in/out or wipe-in/out.
- Pressing and holding the Recording Start/Stop Button **11** allows you to vary the length for the image during fade in/out or wipe in/out.
 - To cancel a fade or wipe, press FADE/WIPE **20** repeatedly until “OFF” appears.

☞ FADER: Fades in/out to a black screen.

☞ MOSAIC (Fader): Gradually turns/returns the picture into/from a mosaic pattern.

☞ SHUTTER (Wipe): A black screen moves in from the top and bottom, closing over the image like a shutter, or a new image pushes open the black screen vertically from the center.





☞ SLIDE (Wipe): A black screen moves in from the left to gradually cover the image, or a new image moves in from right to left.

☞ DOOR (Wipe): Wipes in as the two halves of a black screen open to the left and right, revealing the scene, or wipes out and the black screen reappears from left and right to cover the scene.

☞ CORNER (Wipe): Wipes in on a black screen from the upper right to the lower left corner, revealing the scene, or wipes out from lower left to upper right, leaving a black screen.



☞ WINDOW (Wipe): Wipes in on a black screen from the center of the screen towards the corners, revealing the scene, or wipe out from the corners to the center, leaving a black screen.

Program AE With Special Effects

- 1) Set the Power Switch  to "M".
 - 2) Press P.AE  repeatedly until the desired mode appears.
- To cancel the effect, press P.AE  repeatedly until "OFF" appears.
 - Only one mode can be engaged at a time.
 - In the "High Speed Shutter" or "Sports" modes, picture color may be adversely affected if the subject is lit by alternating discharge-type light sources such as fluorescent or mercury-vapor lights.
 - This function cannot be activated during Night-Alive ( pg. 22).
-  **SPORTS:** High shutter speed clearly captures fast-moving action.















ND : ND EFFECT: A black mist darkens the picture, as when an ND filter is used. Helps to counter the effects of glare on the subject.

FG : FOG: Makes the picture look misty white, as when an external fog filter is attached to the lens. Softens the image and gives it a "fantasy" look. This mode cannot be used when the "VIDEO ECHO" mode ( "Digital Effects") is activated.

 **TWILIGHT:** Dusk, twilight scenery, fireworks, etc., look more natural and dramatic. In this mode, S.LX and AUTO FOCUS in CAMERA MENU ( pg. 18, 19) may not work.

 **S1/2000 (1/2000 sec. High Speed Shutter):** Captures faster action than Sports mode. The screen becomes slightly dark. Use in well-lit situations.

Digital Effects

- 1) Set the Power Switch  to "M".
 - 2) Press DIGIFECT  repeatedly until the desired mode appears.
- To cancel the effect, press DIGIFECT  repeatedly until "OFF" appears.
 - This function cannot be activated during Night-Alive ( pg. 22).
 - Picture Stabilizer cannot be activated during the "CLASSIC FILM", "STROBE" and "VIDEO ECHO" mode.
-  **SEPIA:** Recorded scenes have a brownish tint like old photos. Combine this with WIDE in SYSTEM MENU for a classic look.
- B/W MONOTONE:** Like black and white films, your footage is shot in B/W. Combine this with WIDE in SYSTEM MENU for a classic look.
-  **B. FILTER:** Recorded scenes have a bluish tint.
-  **R. FILTER:** Recorded scenes have a reddish tint.
-  **SOLARI:** The picture is recorded with an effect similar to a painting.
-  **NEGA POSI:** The colors of a picture are reversed.
-  **MOSAIC:** Turns recorded scenes into a mosaic pattern.
-  **STRETCH:** Doubles the width of the picture horizontally.
-  **CLASSIC FILM:** Makes your footage look like a classic movie by shooting in black and white, with a strobing effect, and black bars added at the top and bottom.
-  **STROBE:** Your recording looks like a series of consecutive snapshots.
-  **VIDEO ECHO:** Adds a "ghost" to the subject, giving your recording a "fantasy" feeling. Zoom magnification of over 10X is not available.

USING THE REMOTE CONTROL UNIT

Make sure the remote control is pointed at the remote sensor **80**.

Playback Zoom

To magnify the recorded image up to 10X at any time during playback. Make sure that the TBC mode is activated.

- 1) Press **PLAY** **35** to find the scene of interest.
 - 2) Press **ZOOM (T/W)** **34**. Pressing **T** zooms in. To end zoom press and hold **W** until magnification returns to normal. Or, press **STOP** **37** and then press **PLAY** **35**.
- Due to digital image processing, the quality of the image may suffer.

Animation And Time-Lapse

The remote control lets you set/release interval time and recording time without setting **REC TIME/INT. TIME** (☞ pg. 21) in **SYSTEM MENU**.

Animation

Each time **ANIM.** **39** is pressed, the recording time changes in the following order: 1/4S, 1/2S, 1S, 5S and no indication (off).

Time-Lapse

Each time **REC TIME** **39** is pressed, the recording time changes in the following order: 1/4S, 1/2S, 1S, 5S and no indication (off). Each time **INT. TIME** **44** is pressed, the interval time changes in the following order: 15S, 30S, 1MIN, 5MIN and no indication (off).

Insert Editing

You can record a new scene onto a previously recorded tape. Only the video signal is recorded in this mode.

- 1) Set the Power Switch **12** to "**PLAY**".
- 2) Play back the tape, locate the edit-out point and press **PAUSE** **42**. Press and hold **COUNTER R/M** **20** for more than 1 second to reset the tape counter, then press it again for less than 1 second so that "**M**" appears.
- 3) Press **REW** **36** to go a little beyond the beginning of the scene you want to replace, press **PLAY** **35** to view the recorded tape, and press **PAUSE** **42** exactly at the edit-in point where the new scene should start.
- 4) While holding down **INSERT** **38**, press and release **PAUSE** **42**. **▶** appears.

- 5) To begin Insert Editing, press **START/STOP** **40**. When the counter reaches "0:00:00", editing stops automatically and the camcorder enters the Insert-Pause mode. To end Insert Editing, press **STOP** **37**.

- During Insert Editing, the original audio will be heard from the speaker.
- After step 4), "Retake" (☞ pg. 13) can be performed.
- The tape may stop slightly before or after the designated end point, and noise bars may appear. Neither indicates a defect in the unit.

Audio Dubbing

You can record a new soundtrack on a prerecorded tape (normal audio only). The sound is recorded from the built-in microphone.

Perform steps 1) and 2) of the Insert Editing procedure.

- 3) Press **REW** **36** to go a little beyond the beginning of the scene onto which you want to dub the new audio, press **PLAY** **35** to view the recorded tape, then press **PAUSE** **42** at exactly the point where dubbing should start.
 - 4) While holding down **A. DUB** **43**, press and release **PAUSE** **42**.
 - 5) To begin Audio Dubbing, press **PLAY** **35**. When the counter reaches "0:00:00", Audio Dubbing stops automatically and the camcorder enters the Audio Dub-Standby mode. To end Audio Dubbing, press **STOP** **37**.
- Do not press **REW** **36** or **FF** **41** during Audio Dub-Standby, or the edit points will not be accurate.
 - If the microphone is too close to the TV, or if the TV's volume is too high, whistling or howling may occur.

For Insert Editing/Audio Dubbing

- Insert Editing and Audio Dubbing may not work correctly if the tape contains blank segments, or if the recording speed was changed during the original recording.
- To edit/dub onto a tape, make sure the erase protection tab is in the position that allows recording.
- Do not press **STOP** **37** during Insert Editing or Audio Dubbing, or the edit points will not be accurate.

TROUBLESHOOTING

Before consulting your JVC dealer, please check the following to see if you can correct the problem yourself.

Vertical white lines appear when shooting a very bright object.

- This sometimes occurs when the contrast between the back-ground and the object is great. It is not a defect of the camcorder.

Bright, crystal-shaped spots appear in the LCD monitor and the viewfinder.

- Sunlight is directly entering the lens. This is not a defect of the camcorder.

Colored bright spots appear all over the LCD monitor or the viewfinder.

- The LCD monitor and the viewfinder are made with high-precision technology. However, black spots or bright spots of light (red, green or blue) may appear constantly on the LCD monitor or in the viewfinder. These spots are not recorded on the tape. This is not due to any defect of the unit. (Effective dots: more than 99.99 %.)

Animation or Time-Lapse is not available.

- Before recording in the Animation mode at the very beginning of a tape, set the camcorder to the Recording mode for about 5 seconds, so that the tape runs smoothly. Using the Fade-in function at this point is a good way to begin an animated program (☞ pg. 21, REC TIME/INT. TIME in SYSTEM MENU).

The tape is running, but there is no playback picture.

- The TV has not been set to its VIDEO mode or channel.
- If A/V connection is used, the TV's VIDEO/TV Switch has not been set to VIDEO.

Playback picture is blurred or interrupted.

- The video heads are dirty or worn out. Consult your nearest JVC dealer for head cleaning or replacement.

The tape stops during fast-forward or rewind.

- The Counter Memory Function has been activated (☞ pg. 14, "Counter Memory").

The date and time displays disappear.



- If you remove the power source from the camcorder while the power is on, all settings and selections are erased. Make sure to turn the camcorder's power off before disconnecting the power source.

The tape will not eject.

- The battery pack is running low.
- If the LCD monitor is not open over 60 degrees, the EJECT switch  does not function.

The camcorder is a microcomputer-controlled device. External noise and interference (from a TV, a radio, etc.) might prevent it from functioning properly. In such cases, first disconnect its power supply unit (battery pack, AC Adapter, etc.); and then re-connect it and proceed as usual from the beginning.

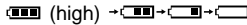
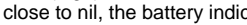
Warning Indications

 (high) →  (exhausted) : Displays the battery remaining power level. As the battery power comes close to nil, the battery indicator  blinks (battery power warning). When the battery power is exhausted, power turns off automatically.

 : Blinks when no cassette is loaded, or when the erase protection tab is not in the position that allows recording.

TAPE END: Appears when the tape ends during recording, playback or fast-forward.

LENS CAP: Appears for 5 seconds after power is turned on if the lens cap is attached.

 **CONDENSATION OPERATION PAUSED PLEASE WAIT:** These 2 warnings appear alternately every 3 seconds if condensation occurs. In this case, all functions except tape eject and power on/off are disabled. Remove the tape, turn the unit off (without removing the power supply), wait a few minutes for the warnings to clear, and turn it on again.

 **HEAD CLEANING REQUIRED USE CLEANING CASSETTE:** These 2 warnings appear alternately every 3 seconds if dirt is detected on the heads during recording. In this case, use an optional cleaning cassette. If the warning remains after cleaning, consult your nearest JVC dealer.

E01—E06 UNIT IN SAFEGUARD MODE REMOVE AND REATTACH BATTERY: The error indications (E01 — E06) show what type of malfunction has occurred. If an error indication and warning appear, turn the unit off, remove the power supply (battery, etc.) and wait a few minutes for them to clear. When it does, you can resume using the camcorder. If the indication remains, consult your nearest JVC dealer.

CAUTIONS

When using the AC Adapter in areas other than the USA

- The provided AC Adapter features automatic voltage selection in the AC range from 110 V to 240 V.

USING HOUSEHOLD AC PLUG ADAPTER

In case of connecting the unit's AC Adapter to an AC wall outlet other than American National Standard C73 series type use an AC plug adapter, called a "Siemens Plug", as shown.

For this AC plug adapter, consult your nearest JVC dealer.

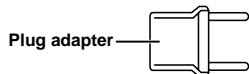

Video Light

DANGER:

- The video light becomes extremely hot. Do not touch it either while in operation or soon after turning it off, otherwise serious injury may result.
- Do not place the camcorder into the carrying case immediately after using the video light, since it remains extremely hot for some time.
- When operating, keep a distance of about 30 cm (11-13/16") between the video light and people or object.
- Do not use near flammable or explosive materials.
- It is recommended that you consult your nearest JVC dealer for replacing the video light.



General Battery Precautions

If the remote control or cassette adapter is not functioning even if it is being operated correctly, the batteries are exhausted. Replace them with fresh ones.

Use only the specified batteries pg. 2 "PROVIDED ACCESSORIES"

Please make note of the following rules for battery use. When misused, the batteries can leak or explode.

1. When replacing batteries, refer to page 2 for the remote control, or read the cassette adapter (C-P6U/C-P7U) instructions.
2. **Do not** use any different size of batteries from those specified.
3. Be sure to install batteries in the correct direction.
4. **Do not** use rechargeable batteries.
5. **Do not** expose the batteries to excessive heat as they can leak or explode.
6. **Do not** dispose of the batteries in a fire.
7. Remove the batteries from the unit if it is to be stored for an extended period to avoid battery leakage which can cause malfunctions.

Battery Packs

The battery packs are nickel-cadmium or nickel metal-hydride batteries. Before using the supplied battery pack or an optional battery pack, be sure to read the following cautions:

1. To avoid hazard . . .

- do not burn.
- do not short-circuit the terminals.
- do not modify or disassemble.
- use only specified chargers.

2. To prevent damage and prolong service life . . .

- do not subject to unnecessary shock.
- avoid repeated charging without fully discharging.
- charge in an environment where temperatures are within the tolerances shown in the chart below. This is a chemical reaction type battery—cooler temperatures impede chemical reaction, while warmer temperatures can prevent complete charging.
- store in a cool, dry place. Extended exposure to high temperatures will increase natural discharge and shorten service life.

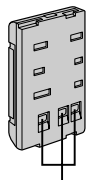

Terminals

- avoid prolonged uncharged storage.
- remove from charger or powered unit when not in use, as some machines use current even when switched off.
- It is normal for the battery pack to be warm after charging, or after use.
Temperature Range Specifications
Charging 10°C to 35°C (50°F to 95°F)
Operation 0°C to 40°C (32°F to 104°F)
Storage -10°C to 30°C (14°F to 86°F)
- Recharging time is based on room temperature of 20°C (68°F).
- The lower the temperature, the longer recharging takes.

Cassettes

To properly use and store your cassettes, be sure to read the following cautions:

1. During use . . .

- make sure the cassette bears the S-VHS-C or VHS-C mark.
- be aware that recording onto prerecorded tapes automatically erases the previously recorded video and audio signals.
- make sure the cassette is positioned properly when inserting.
- do not load and unload the cassette repeatedly without allowing the tape to run at all. This slackens the tape and can result in damage.
- do not open the front tape cover. This exposes the tape to fingerprints and dust.

2. Store cassettes . . .

- away from heaters or other heat sources.
- out of direct sunlight.
- where they won't be subject to unnecessary shock or vibration.
- where they won't be exposed to strong magnetic fields (such as those generated by motors, transformers or magnets).
- vertically, in their original cases.

Main Unit

1. For safety, DO NOT . . .

- open the camcorder's chassis.
- disassemble or modify the unit.
- short-circuit the terminals of the battery pack. Keep it away from metallic objects when not in use.
- allow inflammables, water or metallic objects to enter the unit.
- remove the battery pack or disconnect the power supply while the power is on.
- leave the battery pack attached when the camcorder is not in use.

2. Avoid using the unit . . .

- in places subject to excessive humidity or dust.
- in places subject to soot or steam such as near a cooking stove.
- in places subject to excessive shock or vibration.
- near a television set.
- near appliances generating strong magnetic or electric fields (speakers, broadcasting antennas, etc.).
- in places subject to extremely high (over 40°C or 104°F) extremely low (under 0°C or 32°F) temperatures.

3. DO NOT leave the unit . . .

- in places of over 50°C (122°F).
- in places where humidity is extremely low (below 35%) or extremely high (above 80%).
- in direct sunlight.
- in a closed car in summer.
- near a heater.
- in dusty places such as a beach.

4. To protect the unit, DO NOT . . .

- allow it to become wet.
- drop the unit or strike it against hard objects.
- subject it to shock or excessive vibration during transportation.
- keep the lens directed at extremely bright objects for long periods.
- direct the eyepiece of the viewfinder at the sun.
- carry it by holding the viewfinder or the LCD monitor*. Be sure to hold the main unit with both hands or use the grip.
* Applicable models only.
- swing it excessively when using the shoulder strap.

LCD Monitor

1. To prevent damage to the LCD monitor, DO NOT . . .

- push it strongly or apply any shocks.
- place the camcorder with the LCD monitor on the bottom.

2. To prolong service life . . .

- avoid rubbing it with coarse cloth.

3. Be aware of the following phenomena for LCD monitor use.

These are not malfunctions:

- While using the camcorder, the surface around the LCD monitor and/or the back of the LCD monitor may heat up.
- If you leave power on for a long time, the surface around the LCD monitor becomes hot.

How To Handle a CD-ROM (for applicable models)

- Take care not to soil or scratch the mirror surface (opposite to the printed surface). Do not write anything or put a sticker on either the front or back surface. If the CD-ROM gets dirty, gently wipe it with a soft cloth outward from the center hole using a circular motion.
- Do not use conventional disc cleaners or cleaning spray.
- Do not bend the CD-ROM or touch its mirror surface.
- Do not store your CD-ROM in a dusty, hot or humid environment. Keep it away from direct sunlight.

About moisture condensation . . .

- You may have observed that pouring a cold liquid into a glass will cause drops of water to form on the glass' outer surface. This same phenomenon occurs on the head drum of a camcorder when it is moved from a cool place to a warm place, after heating a cold room, under extremely humid conditions or in a place directly subjected to the cool air from an air conditioner.
- Moisture on the head drum can cause severe damage to the video tape, and can lead to internal damage to the camcorder itself.

Serious malfunctioning

If malfunctioning occurs, stop using the unit immediately and consult your local JVC dealer.

For Your Maintenance

1. After Use

- ① Set the **Power Switch** to "OFF" to turn off the camcorder.
- ② Open the LCD monitor to an angle of over 60 degrees. Slide **EJECT** to open the cassette holder, then remove the cassette.
- ③ Close and lock the cassette holder by pressing the Close button.
- ④ Close and lock the LCD monitor.
- ⑤ Slide **BATTERY RELEASE** to remove the battery pack.
- ⑥ Attach the provided lens cap to the camcorder's lens.

2. Cleaning The Camcorder

- ① Wipe gently the exterior with a soft cloth. Put cloth in diluted mild soap and wring it well to wipe off heavy dirt, then wipe again with a dry cloth.
- ② Open the LCD monitor and wipe it gently with a soft cloth. Be careful not to damage the monitor. Close the LCD monitor.
- ③ Blow the lens with a blower brush, then wipe it gently with lens cleaning paper.
- ④ Turn the eyepiece counterclockwise and pull it out.
- ⑤ Remove dust from the viewfinder using a blower brush.
- ⑥ Re-attach the eyepiece and turn it clockwise.

- Avoid using strong cleaning agents such as benzine or alcohol.
- Cleaning should be done only after the battery pack has been removed or other power units have been disconnected.
- Mold may form if the lens is left dirty.
- When using a cleaner or chemically treated cloth, refer to the cautions that came with it.
- When removing the eyepiece, be sure to hold the viewfinder securely.

Declaration of Conformity

Model Number : GR-SXM745U
Trade Name : JVC
Responsible party : JVC AMERICAS CORP.
Address : 1700 Valley Road Wayne, N. J.
07470
Telephone Number : 973-317-5000

This device complies with Part 15 of FCC Rules. Operation is subject to the following two conditions:

- (1) This device may not cause harmful interference, and (2) this device must accept any interference received, including interference that may cause undesired operation.

Change or modifications not approved by the party responsible for compliance could void the user's authority to operate the equipment. This equipment has been tested and found to comply with the limits for a Class B digital device, pursuant to Part 15 of the FCC Rules. These limits are designed to provide reasonable protection against harmful interference in a residential installation. This equipment generates, uses, and can radiate radio frequency energy and, if not installed and used in accordance with the instructions, may cause harmful interference to radio communications. However, there is no guarantee that interference will not occur in a particular installation. If this equipment does cause harmful interference to radio or television reception, which can be determined by turning the equipment off and on, the user is encouraged to try to correct the interference by one or more of the following measures:

- Reorient or relocate the receiving antenna.
- Increase the separation between the equipment and receiver.
- Connect the equipment into an outlet on a circuit different from that to which the receiver is connected.
- Consult the dealer or an experienced radio/TV technician for help.

This Class B digital apparatus complies with Canadian ICES-003.

Cet appareil numérique de la classe B est conforme à la norme NMB-003 du Canada.

SPECIFICATIONS

Camcorder

General

Format	: S-VHS/VHS NTSC standard
Power source	: DC 11 V --- (Using AC Adapter) DC 6 V --- (Using battery pack)

Power consumption

Viewfinder on	: 4.0 W
LCD monitor on	: 4.5 W
Video light	: 3.0 W

Signal system : NTSC-type

Video recording system

Luminance	: FM recording
Color	: Converted sub-carrier direct recording Conforms to VHS standard

Cassette :  /  cassette

Tape speed

SP	: 33.35 mm/sec. (1-5/16 ips)
EP	: 11.12 mm/sec. (7/16 ips)

Recording time (max.)

SP	: 40 minutes
EP	: 120 minutes (with TC-40 cassette)

Operating

temperature : 0°C to 40°C (32°F to 104°F)

Operating humidity : 35% to 80%

Storage temperature : -20°C to 50°C (-4°F to 122°F)

Weight : Approx. 930 g (2.1 lbs)

Dimensions (W x H x D) : 200 mm x 112 mm x 118 mm
(7-7/8" x 4-7/16" x 4-11/16")
(with the LCD monitor closed and with the viewfinder fully tilted downward)

Pickup : 1/4" format CCD

Lens : F1.6, f = 3.9 mm to 62.4 mm,
16:1 power zoom lens with auto iris and macro control, filter diameter 40.5 mm

Viewfinder : Electronic viewfinder with 0.5" black/white CRT

White balance adjustment : Auto/Manual adjustment

LCD monitor : 3.5" diagonally measured, LCD panel/TFT active matrix system

Speaker : Monaural

Connectors

Video : 1 V (p-p), 75 Ω unbalanced, analog output (via Video output connector)

Audio : 300 mV (rms), 1 k Ω analog output (via Audio output connector)

Digital : \varnothing 3.5 mm, 4-pole, mini-head jack

S-Video : **Y** : 1 V (p-p), 75 Ω , analog output
C : 0.29 V (p-p), 75 Ω , analog output

AC Adapter



Power requirement

U.S.A. and Canada : AC 120 V \sim , 60 Hz

Other countries : AC 110 V to 240 V \sim ,
50 Hz/60 Hz

Output : DC 11 V --- , 1 A

Optional Accessories

- Battery Packs BN-V12U, BN-V20U, BN-V400U
- A/V (Audio/Video) Cable
- Compact S-VHS () Cassettes ST-C-40/30/20
- Compact VHS () Cassettes TC-40/30/20
- Active Carrying Bag CB-V7U

Some accessories are not available in some areas. Please consult your nearest JVC dealer for details on accessories and their availability.

Esta cámara de video posee un sistema de alimentación de 2 vías que le permite seleccionar la fuente de alimentación más apropiada. No utilice las unidades de alimentación suministradas con otro equipo.

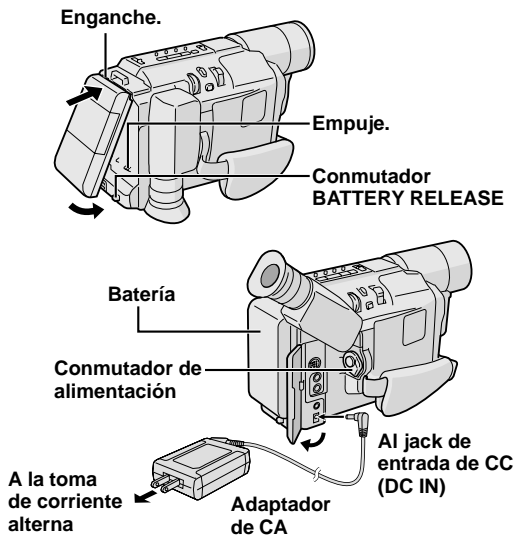

CARGA DE LA BATERÍA

- 1) Asegúrese de que la batería esté colocada en la cámara de video. Enganche el extremo a la cámara de video y presione la batería hacia el interior hasta que quede bloqueada en su lugar.
 - Si la batería está colocada en la posición equivocada, puede ocurrir un fallo.
- 2) Ajuste el conmutador de alimentación **12** en "OFF". Conecte el adaptador de alimentación CA a la cámara de video.
- 3) Enchufe el adaptador de alimentación CA en una toma de corriente alterna. La lámpara indicadora CHARGE **18** de la cámara de video parpadeará para indicar que la carga se ha iniciado.
- 4) Cuando la lámpara indicadora CHARGE **18** pare de parpadear, pero permanece encendida, la carga ha finalizado. Desenchufe el adaptador de alimentación CA de la toma de corriente alterna. Desconecte el adaptador de alimentación CA de la cámara de video.

Para la extracción de la batería . . .

... deslice BATTERY RELEASE **8** y extraiga la batería.

Batería	Tiempo de carga
BN-V11U	aprox. 1 h 30 min
BN-V12U (opcional)	aprox. 1 h 30 min
BN-V20U (opcional)	aprox. 2 h 20 min
BN-V400U (opcional)	aprox. 4 h 30 min

Los tiempos de carga son para una batería completamente descargada.

USO DE LA BATERÍA

Efectúe el paso **1)** de "CARGA DE LA BATERÍA".

Tiempo de grabación aproximado (unidad: min)

Batería	Visor conectado	Monitor LCD conectado
BN-V11U	95 (50)	80 (45)
BN-V12U (opcional)	95 (50)	80 (45)
BN-V20U (opcional)	150 (85)	135 (75)
BN-V400U (opcional)	360 (205)	315 (190)

() : cuando el foco de video está encendido

USO DE LA ALIMENTACIÓN DE CA

Conecte el adaptador de CA en la cámara de video (ver pasos **2)** y **3)** de "CARGA DE LA BATERÍA".

- El adaptador de CA suministrado presenta una selección automática de voltaje con límites de CA de 110 V a 240 V.

ATENCIÓN

Antes de retirar la fuente de alimentación, asegúrese que la alimentación de la cámara de video esté desactivada. De lo contrario puede ocurrir un fallo en la cámara de video.

REFRESCO:

Asegúrese de descargar completamente una batería antes de recargarla o guardarla durante un intervalo de tiempo prolongado, de lo contrario, el desempeño de la batería será reducido.

- 1) Ejecute los pasos de **1)** hasta **3)** de "CARGA DE LA BATERÍA".
- 2) Presione REFRESH **21** durante más de 2 segundos. La lámpara REFRESH **19** destellará para indicar que la descarga se ha iniciado.
- 3) Cuando finalice la descarga, la carga será iniciada automáticamente y la lámpara CHARGE **18** empieza a destellar.

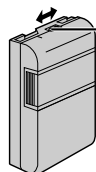

El **marcador de carga** le ayuda a recordar si la batería ha sido cargada o no. Son suministrados dos colores (rojo y negro) — usted elije qué color significa que está cargada y qué color significa que está descargada.

- Durante la carga o descarga, la cámara de video no puede ser operada.
- No es posible efectuar la carga o descarga si se utiliza un tipo de batería equivocado.
- Cuando efectúe la carga de la batería por primera vez o después de un largo periodo de almacenamiento, la lámpara CHARGE **(B)** puede no se encender. Retire la batería de la cámara de video, luego intente la carga nuevamente.
- Si el tiempo de funcionamiento de una batería completamente cargada es extremadamente corta, la batería puede estar estropeada. Adquiera una nueva batería.
- Efectúe la carga en lugares donde la temperatura sea entre 10°C y 35°C. La gama de temperatura ideal para efectuar la carga es de 20°C a 25°C. Si el ambiente es muy frío, la carga puede resultar incompleta.
- El tiempo de carga varía de acuerdo con la temperatura ambiente y el estado de la batería.
- Ya que el adaptador de CA procesa electricidad internamente, el mismo se calentará durante el uso. Asegúrese de utilizarlo sólo en áreas bien ventiladas.
- La siguiente operación interrumpirá la carga o la descarga:
 - Ajuste el interruptor de alimentación **(12)** en "PLAY", "A" o "M".
- Desconecte el adaptador de CA de la cámara de video.
- Desenchufe el adaptador de CA del tomacorriente de CA.
- Extraiga la batería de la cámara de video.
- Utilizando el adaptador de alimentación/cargador de CA AA-V15, es posible cargar la batería BN-V11U/V12U/V20U/V400U sin la cámara de video. Sin embargo, no es posible utilizarlo como un adaptador de CA.
- Para evitar interferencias en la recepción, no utilice el adaptador de CA cerca de una radio.
- El tiempo de grabación es significativamente reducido cuando el modo de zoom o el modo de espera de grabación es activado repetidamente o el monitor LCD es utilizado repetidamente.
- Antes del uso prolongado, se recomienda que prepare suficiente batería para cubrir 3 veces el tiempo de filmación planeado.

Si la unidad comienza a funcionar mal, deje de usarla inmediatamente y consulte a su concesionario local de JVC.

Colocación/Extracción de un cassette

- 1) Abra completamente el monitor LCD. Deslice EJECT **25** hasta que el compartimiento de cassette se abra. No aplique fuerza para abrirlo.
 - 2) Inserte o retire un cassette. Cuando lo inserte, asegúrese de que la etiqueta esté hacia fuera. **21** aparece cuando un cassette es insertado.
 - 3) Presione el botón de cierre **23** para cerrar el compartimiento de cassette hasta que se trabaje. Cierre el monitor LCD.
- Cerrar el monitor LCD mientras que el compartimiento de cassette todavía está abierto puede causar daños en el monitor LCD.
 - Asegúrese que la lengüeta de protección contra borrado esté en la posición que permite la grabación. De lo contrario, deslice la lengüeta. Algunos cassettes tienen lengüetas extraíbles. Si la lengüeta ha sido extraída, cubra el orificio con cinta adhesiva.
 - El compartimiento de cassette no puede ser abierto mientras la cámara de video está en el modo de grabación o desconectada de la fuente de alimentación.

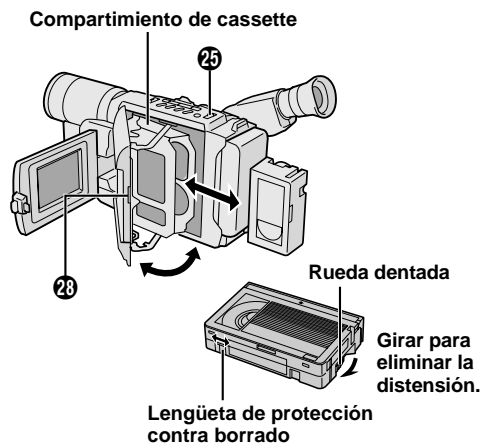

GRABACIÓN

- 1) Retire el cubreobjetivo. Ajuste el conmutador de alimentación **12** en "A" o **M**.
 - Filmación utilizando el visor:** Asegúrese que el monitor LCD esté cerrado y bloqueado.
 - Filmación utilizando el monitor LCD:** Asegúrese que el monitor LCD esté completamente abierto.
- La cámara de video ingresa al modo de Espera de grabación y PAUSE **20** es mostrado.
- Si inclina el monitor LCD hacia arriba hasta 180 grados, el visor se vuelve a encender y la imagen monitoreada puede ser visualizada tanto en el monitor LCD como en el visor, de manera que la persona que está filmando puede visualizarse así misma.
- 2) Presione el botón de inicio/parada de grabación **11**. **REC 7** aparece mientras la grabación está en progreso.
- Para interrumpir la grabación, presione el botón de inicio/parada de grabación **11**. La cámara de video reingresa al modo de espera de grabación.

Para ajustar el brillo del monitor LCD, gire el disco BRIGHT **1** hasta que el indicador de nivel de brillo **13** del mostrador se mueva y logre el brillo apropiado.

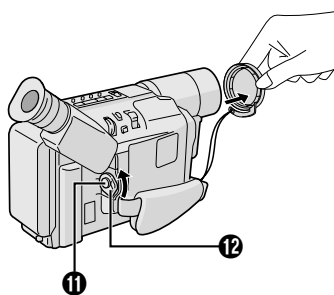

REPRODUCCIÓN

- 1) Cargue una cinta.
- 2) Ajuste el conmutador de alimentación **12** en **PLAY**. Para iniciar la reproducción, presione **▶/II** **16** o **⏪**.

Para interrumpir momentáneamente (reproducción de imágenes fijas), presione **▶/II** **16** o **12**. Para interrumpir la reproducción, presione **■** **14**. Presione **◀◀** **15** para rebobinar, o **▶▶** **17** para avanzar rápido la cinta. La búsqueda de imagen a alta velocidad (Búsqueda rápida) es posible presionando **◀◀** **15** o **▶▶** **17** durante la reproducción (manteniendo presionado **◀◀** **15** o **▶▶** **17** durante la reproducción continuará la búsqueda hasta que sea liberado). Para reanudar la reproducción normal, presione **▶/II** **16** o **⏪**.

O simplemente reproduzca la cinta en un VCR de VHS utilizando el adaptador de cassette.

☞ p. 16

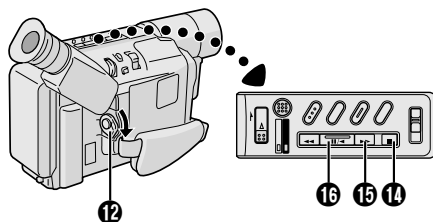

Para GRABACIÓN DE VÍDEO/REPRODUCCIÓN DE VÍDEO

- La cámara de video se desactiva automáticamente después de 5 minutos en el modo de espera de grabación o modo de parada. Para activarla otra vez, ajuste el conmutador de alimentación **12** en OFF, luego en "A", "M" o "PLAY".
- Cuando el conmutador de alimentación **12** esté ajustado en "A", "M" o "PLAY" y el monitor LCD está abierto en un ángulo de 60 grados o más, el monitor LCD se enciende y el visor se apaga automáticamente para ahorrar energía.
- La imagen reproducida puede ser visualizada en el visor (con el monitor LCD apagado), en el monitor LCD o en un TV conectado (☞ pág. 15, "Conexiones a un TV/VCR").
- Para retirar las conexiones, ☞ pág. 21, DISPLAY o OSD OUTPUT en SYSTEM MENU.
- Para controlar el volumen de los altavoces*, deslice VOL. **3** hacia "+" para aumentarlo o hacia "-" para disminuirlo. Mientras filme, el sonido no será escuchado desde los altavoces*.
- Si TBC (☞ pág. 14) está activado durante la reproducción de imágenes fijas, las barras de ruidos no aparecerán.